

Practicon® BFC³™ Powered Impression Gun

Instructions for Use

Thank you for purchasing the **BFC³** (*Better Faster Comfort, Control, Compatibility*) **Powered Impression Gun**, the first cordless, handheld, motorized impression gun that dispenses standard 25ml, 50ml, and 75ml 1:1 or 2:1 automix cartridges. With proper use and care, BFC³ will make your impression procedures faster and easier than ever.

 Please read and understand all instructions before using this device, and save this manual for your reference. This manual is subject to change without notice.

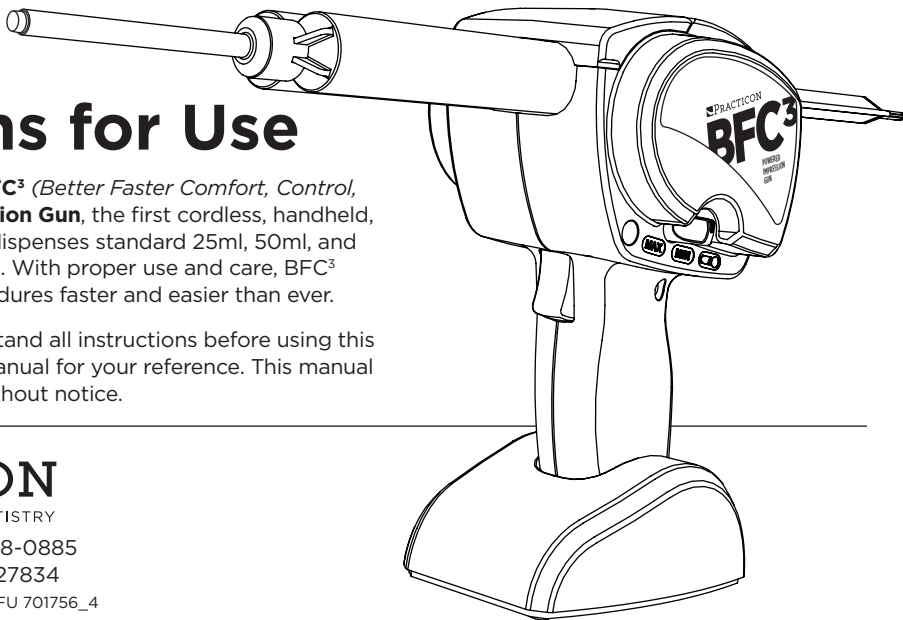

PRACTICON

PRACTICAL INNOVATIONS FOR DENTISTRY

1-800-959-9505 • Fax 1-800-278-0885

practicon.com • Greenville, NC 27834

Made in USA of US and imported parts • IFU 701756_4

SYMBOLS USED



Hazard warning



Read instructions before use



Serial number



Keep dry



Manufacturer



Do not dispose of with normal household waste

IPX0 Ordinary equipment

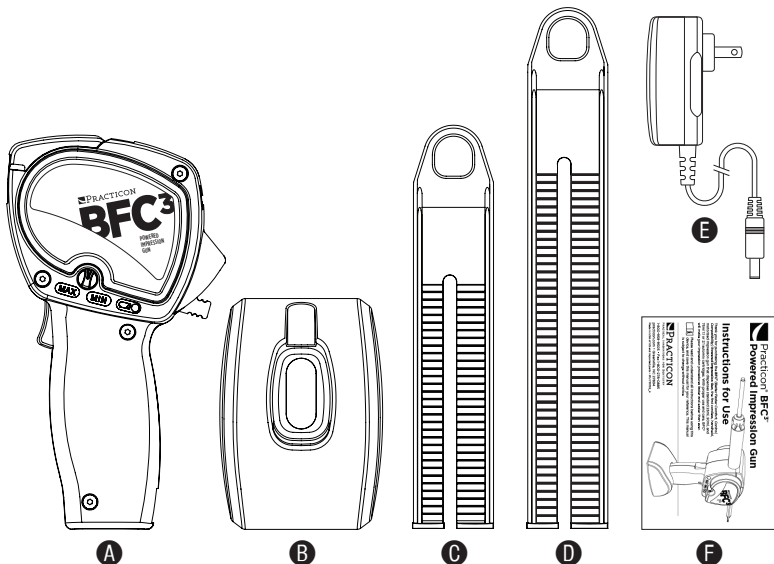

PACKAGE CONTENTS

Item	Description	Qty
A	BFC ³ Impression Gun	1
B	Countertop Stand	1
C	50ml/25ml Plunger	1
D	75ml Plunger	1
E	Battery Charger	1
F	Instructions for Use	1

Quick Start



Watch the online tutorial video before using your BFC³. Practicon.com/bfc3.



Charge your BFC³ for three hours or until the LED on the wall charger turns from red to green.

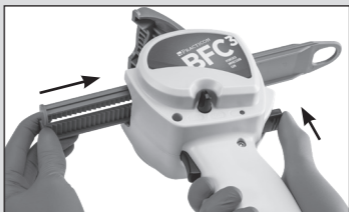

Insert a plunger into the front of the BFC³. Push up on the back plunger release lever to allow the plunger to slide completely into the BFC³.



Insert material cartridge into BFC³ with the cartridge notch facing down. Close the cartridge door completely.

Continue →



Attach mixing tip to material cartridge.
Mixing tip hub color must match material cartridge cap color.



Adjust the dispensing speed.
Practicon recommends using a slower speed for lighter body materials.



Replace the mixing tip after each use.



The BFC³ can be cleaned with surface disinfectant. Do not autoclave your BFC³.

Should your BFC³ not perform as expected, please refer to all printed instructions included with your BFC³, or call our toll-free number at 1-800-959-9505 and speak with any of our customer service representatives.

Product Information

BFC³ COMPONENTS AND CONTROLS

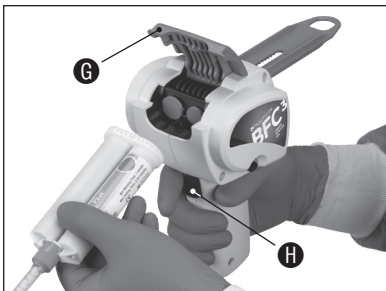

G Cartridge door
Raise to open and insert/remove automix cartridge. Close completely before use.

H Dispensing activation trigger

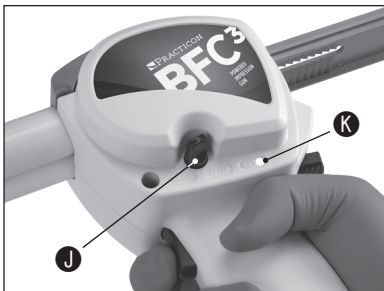

J Dispensing speed control
Adjustable from 0.6ml/sec. (min) to 1.7ml/sec. (max)

K Low battery LED

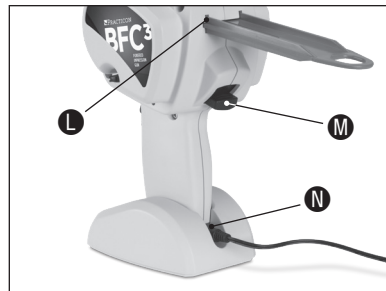

L Plunger slot

M Plunger release lever
Press upward to insert, withdraw, or remove plunger

N Battery charger connector

CHARGE THE BATTERY FULLY BEFORE USING THE BFC³ FOR THE FIRST TIME

Insert the charging cable into the connector **N** at the base of the BFC³ handle and then place the BFC³ into the stand so the charging cable extends out the back of the stand. The LED indicator on the wall charger will change from red to green when the battery is fully charged. A full charge can take up to 2½ hours.



**DISCONNECT CHARGER FROM BFC³ PRIOR TO USE.
UNIT WILL NOT OPERATE WITH BATTERY CHARGER CONNECTED.**

PREPARING THE BFC³ FOR USE

Select the 50ml plunger **C** or 75ml plunger **D** as appropriate for your material cartridge. Open the cartridge door **G**. Hold the BFC³ in one hand and press upward on the plunger release lever **M** with your thumb. With the other hand, insert the plunger **teeth side down** into the plunger slot **L** in the front of the unit and slide it back as far as it will go. Release the plunger release lever. The BFC³ is now ready to load.

OPERATION

Using the BFC³ is very much like using a manual impression gun, only easier. Instead of having to repeatedly squeeze a large spring-loaded trigger with your hand, BFC³ dispenses automix material with the press of a button.

LOADING A CARTRIDGE

Press the plunger release lever **M** upward with your thumb, pull the plunger back until it stops, and then release the lever. Open the cartridge door **G** and insert an automix cartridge **notch side down**. **Close**

the cartridge door. Press the plunger release lever again and slide the plunger forward until it contacts the cartridge. Release the lever.

ADJUSTING THE FLOW RATE

The BFC³ can dispense material at a rate that ranges from 0.6 to 1.7ml/sec. Adjust the flow rate by rotating the dispensing speed control **J** between the MIN and MAX settings. Experiment with different flow rates to find the setting that works best for your practice and procedures.

DISPENSING MATERIAL

As with all impression guns, express the first drops of material onto a paper towel or tray liner.

Attach a **new, unused mixing tip** to the material cartridge. **Be sure the hub color of the mixing tip matches the cartridge cap color**. Using the wrong size mixing tip can prevent proper operation and damage the unit.

Press the dispensing activation trigger **H** with your index finger to start the flow of material. Release the trigger when enough material has been dispensed.

The BFC³ includes an anti-drip feature that momentarily reverses the plunger when the dispensing trigger is released, and an auto-stop feature with overload protection when a cartridge has been emptied.

CHARGING THE BATTERY

Use only the charger that came with your BFC³. Use of another charger could damage the unit and will void the warranty.

With a fully charged battery, the BFC³ can dispense about 60 full 50ml heavy-body VPS cartridges. When battery output is reduced, the low battery LED  will illuminate, indicating that the BFC³ battery should be charged soon. The BFC³ will dispense up to 10 full cartridges after the low battery LED illuminates.

The BFC³ battery is rated for 500 recharges (about 30,000 cartridges) before replacement will be required. Contact Practicon for battery replacement service. Do not attempt to open the unit or service the battery.

CLEANING AND DISINFECTION

This product must be disinfected for each patient. Failure to follow these guidelines could damage the device and void the warranty.

Clean the body of the device and plungers with disinfectant wipes. Follow all disinfectant manufacturer's guidelines for use.

- Do not use any cleaner containing bleach.
- Do not immerse in liquid.
- Do not place in autoclave.

TROUBLESHOOTING

Problem	Resolution
Cannot insert plunger	Insert the plunger into the slot on the front of the unit teeth side down . The slot is keyed so that the plunger can only go in one way.
Dispensing is too slow/fast	Adjust the dispensing speed control to increase/decrease the flow.
Unit will not dispense material	Cartridge is empty and auto-stop engaged; replace cartridge. Battery charger is still connected to unit (by design, unit will not operate with charger connected); disconnect battery charger from BFC ³ .
Popping or clicking noise when dispensing material	Plunger has been damaged as a result of using an old or incorrectly sized mixing tip. Contact Practicon.
Battery will not charge	Contact Practicon for battery service. Do not attempt to open the unit or service the battery.

PRODUCT SPECIFICATIONS

Type of Information	Specifications
Device Name	BFC ³ Powered Impression Gun
Model Number	70-1756
Battery	Rechargeable 11.1V lithium-ion
Battery charger	12.6V/500mA with LED indicator
Charging time	2½ hours (full charge)
Flow rate	Adjustable from 0.6 to 1.7ml/sec.
Device Dimensions	4"W x 4"D x 7"H (overall)
Device Weight	28.1 oz.
Protection from Ingress of Liquid	IPX0



MANUFACTURER

PRACTICON, INC.
1112 SUGG PARKWAY
GREENVILLE, NC 27834 USA

TEL: +1 (252) 752-5183
FAX: +1 (252) 752-2439

WEBSITE: practicon.com
EMAIL: ccr@practicon.com

WARNINGS



AMBIENT CONDITIONS

Do not store the device in humid surroundings. Do not place the device where it may come in contact with liquids. Do not expose the device to any heat sources. Do not charge, operate, or store the device at high temperatures. Comply with the specified operating and storage conditions.



ELECTRIC SHOCK HAZARD

BFC³ is an electric device designed to meet worldwide safety standards. To avoid electric shock:

- Do not attempt to open or alter the unit in any way. Any attempt to open the unit will invalidate the warranty. Only the service centers authorized by Practicon can open the unit housing and repair the device.
- Do not put any foreign objects into the housing of the unit.



BATTERY

Do not store at temperatures above 104°F (40°C). If unit is stored six months or longer, recharge battery fully before using.



DISPOSAL

For environmental reasons, please dispose of unit according to local environmental guidelines or regulations regarding lithium-ion batteries. Do not dispose of unit in fire.



REPAIRS AND DEFECTS

Do not use the device if you suspect it is damaged or defective. If batteries are defective, do not transport the device by air under any circumstances.

Warranty

Practicon, Inc. warrants this product to be free of manufacturing defects for a period of one (1) year from the date of purchase, deemed as the date of the invoice. Units returned due to manufacturing defects within the warranty period will be repaired or replaced at our discretion. The following are expressly excluded from the warranty:

- Damage and/or failure of the equipment caused by dropping and/or jolting during handling after purchase and/or during normal use.
- Damage and/or failure of the equipment caused by natural disasters, such as earthquakes, floods, lightning, pollution, incorrect electrical voltage, and voltage spikes.
- Battery failure.

IMPROPER USE OR ANY ATTEMPT TO OPEN THE UNIT WILL INVALIDATE THE WARRANTY.

PURCHASE INFORMATION

Record information about your BFC³ purchase in the space below.

Serial Number _____

Date of Invoice _____

REPLACEMENT PARTS

Only use original Practicon components/accessories.

Item Number	Description	Qty/Unit
71-51589	Plunger Set	1 ea 50ml and 75ml
71-51590	Battery Charger	1 ea





Practicon® Lock-n-Reload™ Automix Cartridge Couplers

70-9813 · 20/pack

- Works to combine partially used “leftover” material cartridges.
- Saves time and motion spent switching cartridges mid-procedure.
- Keyed design eliminates the chance of accidental cross-mixing of impression materials during refills.
- Twist-lock prevents cartridge separation during transfer.
- For single-use with rounded flange, 50ml automix cartridges.

Instructions (diagram on other side)

Important: Before transferring material, be certain that donor and receiver cartridges have the same base/catalyst orientation.

1. Load donor cartridge into dispensing gun. Squeeze trigger until impression material is visible.
2. Push coupler onto mouth of donor cartridge (Figure 1). Make sure key tab on coupler slides into notch on cartridge. **DO NOT** rotate coupler at this time.
3. Slide receiver cartridge onto coupler and hold in place (Figure 2).
4. Turn coupler firmly in direction of arrow until it locks (Figure 3).
5. Gently squeeze trigger to transfer impression material to receiver cartridge. When finished transferring, disconnect gun and rotate coupler in opposite direction to remove filled receiver cartridge.
6. Dispose of donor cartridge and coupler together.

Manufactured for

 **PRACTICON**

PRACTICAL INNOVATIONS FOR DENTISTRY

1-800-959-9505 • Fax 1-800-278-0885

practicon.com • Greenville, NC 27834

Made in China • Inner Pack 709813_5

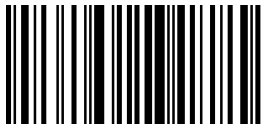

723896016015

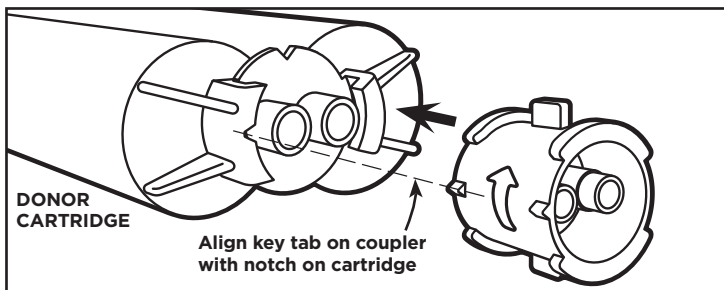

Figure 1. Push coupler onto mouth of donor cartridge.

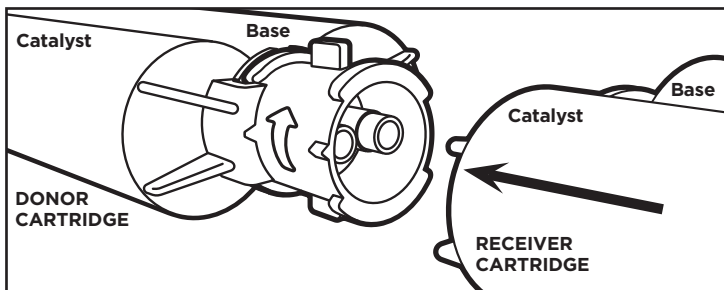

Figure 2. Slide receiver cartridge onto coupler and hold in place.

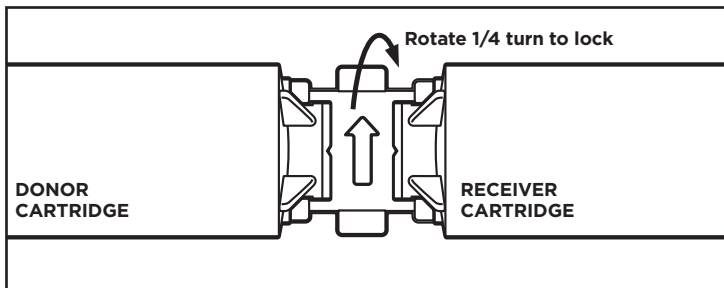

Figure 3. Turn coupler firmly in direction of arrow until it locks.